

LSV6-16-2 NOSP

二位二通电磁阀 双向止回型

说明 DESCRIPTION

A solenoid operated, 2-way, 2-position, normally open, poppet-type bi-directional cartridge valve.

二位，二通，常开型座阀式电磁阀

工作 OPERATION

When de-energized, the poppet allows flow in both directions. When energized, the valve blocks flow in both directions.

失电时，阀芯开启，②到①，①到②互通；
得电时，此阀截止油液双向流动。

手控应急 Operation of Manual Override Option

To override, push button in to activate. To return to normal valve function, release button. 请用工具按下并按住按钮，②与①双向截止；松开按钮，返回常态。

SYMBOL

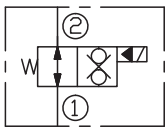

技术参数 SPECIFICATIONS

最大工作压力(Max. Operating Pressure):	350bar
流量(Flow):	See PRESSURE DROP VS.FLOW graph.
内泄漏(Internal Leakage):	5drops/min.(滴/分) max. at 350 bar
温度(Temperature):	-40°F to +212°F(-40°C to +100°C)
线圈额定负载(Coil Duty Rating):	Continuous from 85% to 115% of nominal voltage(连续工作电压)
过滤(Filtration):	See page (参见) N-1
油液(Fluids):	Mineral-based fluids with viscosities of 7.4 to 420 cSt.(矿物油粘度)
插孔(Cavity):	16-2,See page M-3
阀块材料(Body Material):	Steel & Ductile iron rated to 350bar 钢和球铁允许使用最大压力350bar

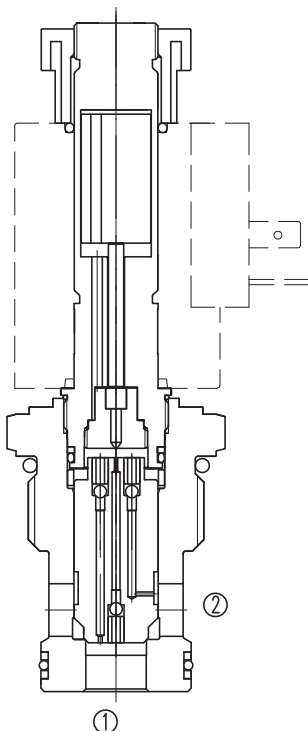

压力 - 流量曲线 PRESSURE DROP VS.FLOW

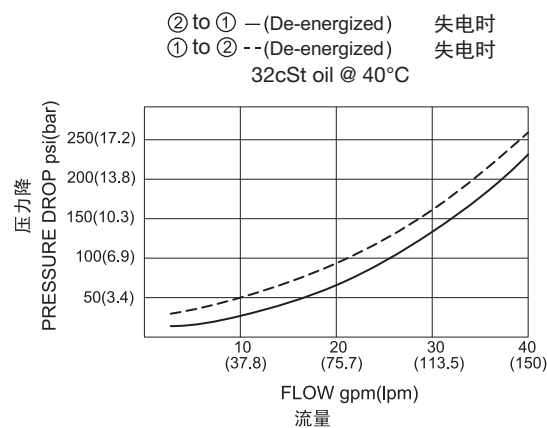

订货代号 TO ORDER

LSV6 - 16 - 2 NO SP - * - * * - * *

┌───┐
┌──┐
┌──┐
┌──┐
┌──┐
┌──┐
┌──┐
┌──┐
┌──┐

1
2
3
4
5
6
7
8
9

<p>1 功能 LSV6= 电磁阀 Solenoid Valve</p>	<p>7 电压 Voltage 1=12 VDC 2=24 VDC 3=110 VAC 4=220 VAC 7=48 VDC 8=24 VAC 9=72 VDC</p>	<p>9 阀块油口 Body Porting 空白 Blank= 不带阀块 None 16T=SAE 16 8G=G 1</p> <p>※ 阀块详见章节 K-9 其它螺纹油口也是可选择的 Other Porting Is Available</p>
<p>2 规格 Size 16=16 规格</p>	<p>8 线圈连接 Coil Connection D= Double Lead 双线 H= Hirschmann 三插 S= Single Lead 单线 ER= Deutsch Connector(Water-proof Coil) 德意志插座(防水线圈) B= Double Spade 双插</p>	
<p>3 流道类型 Flow Path 2= 二通</p>		
<p>4 模式 NO= 常开 Normally Open</p>		
<p>5 类型 SP= 锥阀型 Poppet</p>		
<p>6 手控应急 空白 Blank= 无手控应急 None M= 手控应急 Manual Override</p>		

安装尺寸 INSTALLATION DIMENSIONS

Coil Must Be Installed With Letter Up
安装线圈时，字母必须朝上。

Unit=Millimeters

